

Stainless Steel Magnetic Drive Centrifugal Pumps

Versatile – Space-Saving – Safe

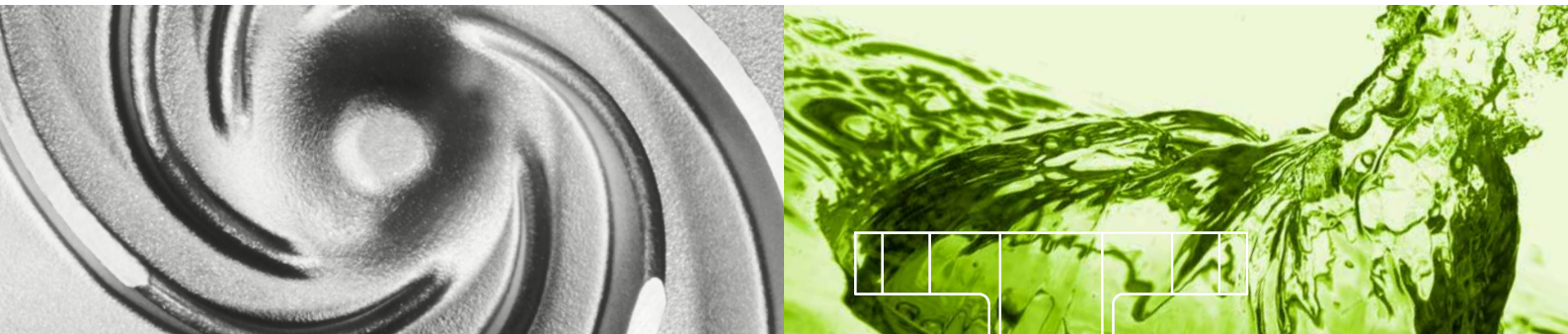

MKPP

Magnetic drive in-line chemical process peripheral pump

SZMK

Magnetic drive in-line chemical process pump

Designed to:

DIN EN ISO 2858, 5199 and 15783

Compliant with:

EC Machinery Directive

EC ATEX Directive

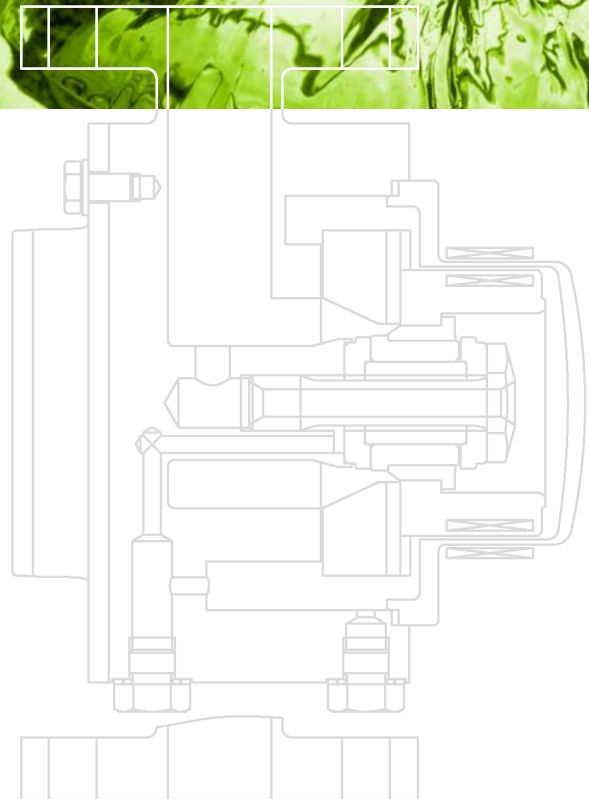



Open impeller of the MKPP magnetic drive in-line chemical process peripheral pump



CP Pump Systems

Stainless Steel Magnetic Drive Centrifugal Pumps

Our company

CP is a highly innovative Swiss company with a rich tradition. Since 1948 we have specialised in developing and manufacturing premium quality high-tech products and providing services for international customers with the most rigorous requirements.

We produce reliable and innovative centrifugal pumps for the chemical, pharmaceutical, petrochemical, biotechnology, food and beverage industries. CP is represented in over 70 countries through its network and offers first-class customer services. This proximity guarantees customers worldwide an efficient local service.

Reflecting our deep commitment to energy efficient products and services, we deliver environmentally friendly solutions that always go hand in hand with maximum safety and economy. As a pioneer in this area, we advise and assist customers with a wide range of needs – throughout the value chain.

CP operates a quality management system certified to ISO 9001.

Energy efficiency in industry

Nowadays, industry is facing increasing demands to improve sustainability and energy efficiency. Pumps are considered to play a key role because they offer vast potential to save energy and costs. Already recognising this back in 1999, CP took action and has become a pioneer in energy-saving pumping systems.

In recent years, we have continuously enhanced the hydraulic performance of numerous pump systems, increasing their efficiency by up to 30 per cent. At the same time, we have steadily improved pump safety, a mission we have vigorously pursued ever since our company was established in 1948.

We are wholeheartedly committed to promoting sustainable manufacturing in industry around the world. Our customers benefit from a comprehensive range of solutions that reduce costs and CO₂ emissions over the long term. Cleaner pumps, cleaner planet: we firmly believe that sustainable research, thinking and action always pay off for everyone.

Stainless steel magnetic drive centrifugal pumps

The sealless MKPP and SZMK magnetic drive pumps are ideal to meet the stringent requirements of chemical processing and a multitude of other industries. These highly advanced and extremely energy efficient pumps are built to handle a huge variety of fluids reliably and absolutely safely.

With their special design, the MKPP and SZMK require no plain bearing carrier. Optimum lubrication and cooling of the single, centrally located impeller bearing assembly with the process fluid gives the pumps excellent running characteristics.

The pump impeller rotates stably about a stationary axis on the gyroscopic principle, maintaining a perfect hydraulic balance. This minimises bearing loads, increasing the reliability of pump operation.

Wetted parts of the pump casing are machined from rolled bar stock, ensuring that the material is non-porous and impermeable. By using rolled bar stock, we can also offer a very wide choice of materials of construction to tailor the pumps exactly to the particular pumping application, and especially to the corrosive medium to be handled.

Added to their compact design, the MKPP and SZMK pumps are constructed with just a few, robust parts. The small number of components facilitates assembly and minimises the costs of spare parts, maintenance and servicing. With their vertical in-line design, the MZPP and SZMK take up less space than conventionally mounted pumps and can be fitted into any installation easily and inexpensively.

MKPP

Stainless Steel Magnetic Drive In-Line Chemical Process Peripheral Pump

The MKPP features a peripheral impeller. This type of impeller allows the pump to generate high head at low flow rates, making it perfect for dosing and injection applications.

Technical data

Capacities (min./max.)	0.25 to 4 m ³ /h (1.10 to 17.61 gpm)
Heads (min./max.)	1 to 40m (3.28 to 131.23 ft)
Temperatures (min./max.)	-100 to +200°C (-148° to +392°F)
Kinematic viscosities	0.5 to 350 mm ² /s (cSt)
Solids handling	0%

Directives

EC Machinery Directive
EC ATEX Directive

Standards

DIN EN ISO 5199
DIN EN ISO 15783

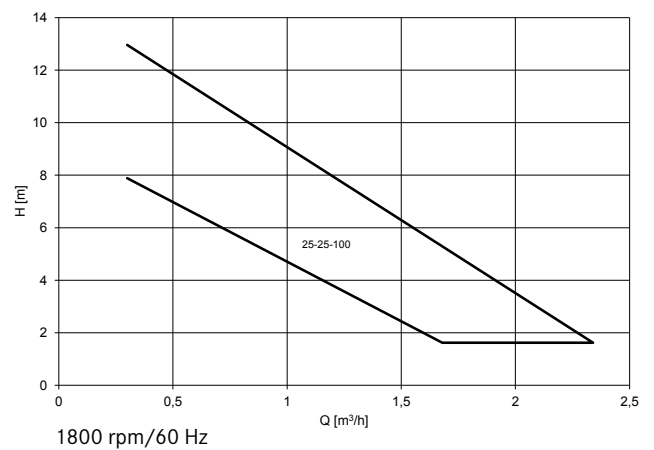
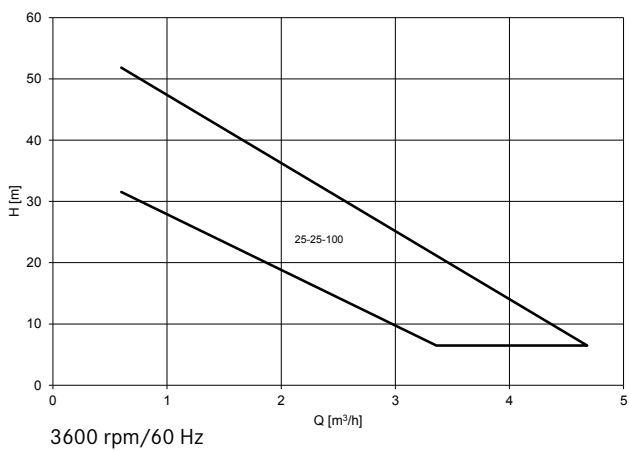
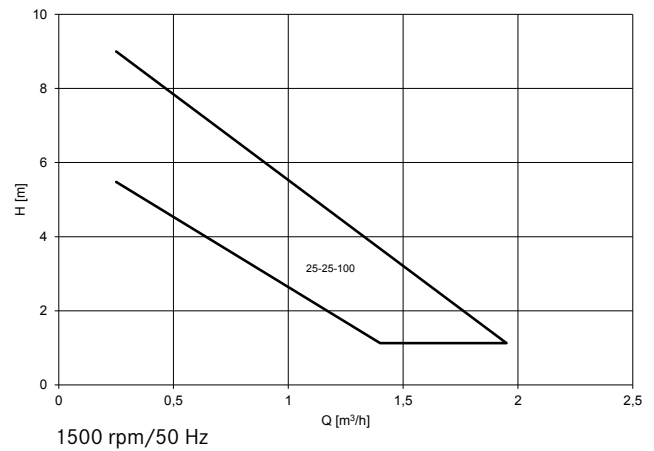
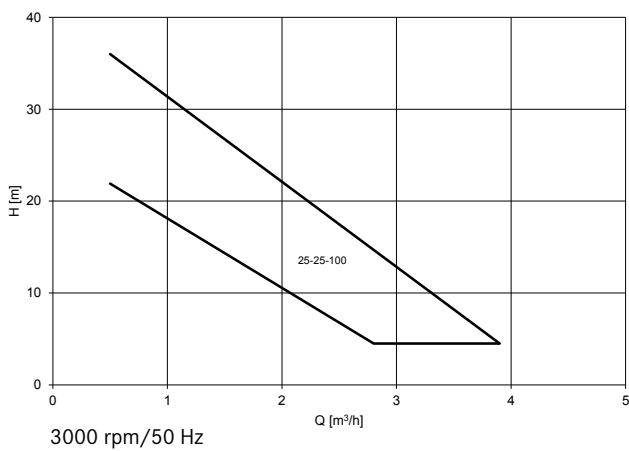

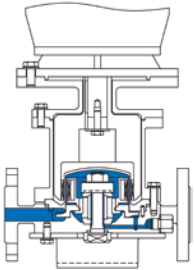

Vertical in-line close-coupled MKPP
with stand
-100°C to +200°C



MKPP with stand and motor
vertical in-line close-coupled (-100°C to +200°C)

SZMK

Stainless Steel Magnetic Drive In-Line Chemical Process Pump

The SZMK features a non-clog, wear-resistant open impeller for reliable handling of fluids containing solids. Depending on the process medium, it can pump suspended solids in concentrations up to 30% with a particle size up to 1 mm.

Technical data

Capacities (min./max.)	0.5 to 40 m ³ /h (2.20 to 176.1 gpm)
Heads (min./max.)	1.4 to 22m (4.6 to 72.2 ft)
Temperatures (min./max.)	-100 to +200°C (-148 to +392°F)
Kinematic viscosities	0.5 to 350 mm ² /s (cSt)
Solids handling	up to 30% solids concentration and 1 mm particle size, depending on the pumped fluid*

Directives

EC Machinery Directive

EC ATEX Directive

Standards

DIN EN ISO 5199

DIN EN ISO 15783

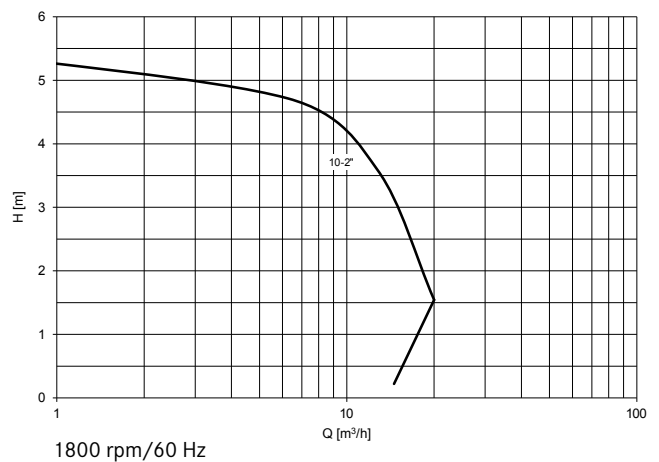
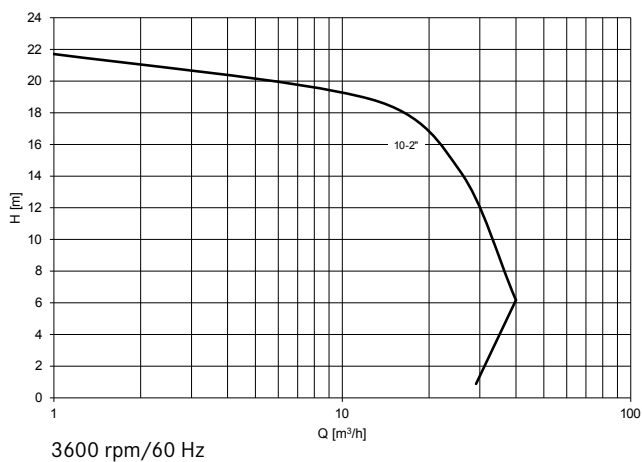
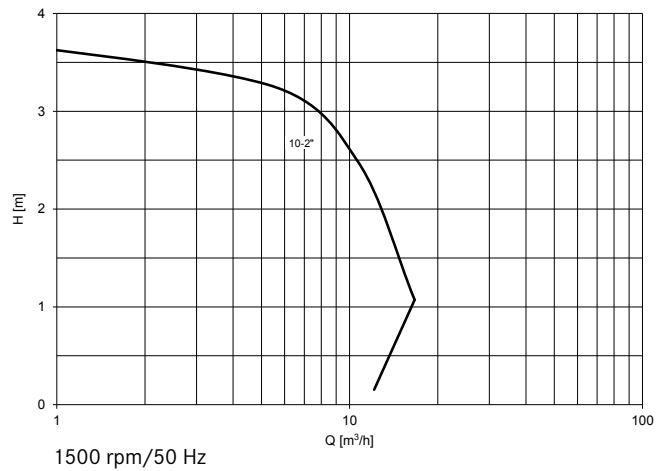
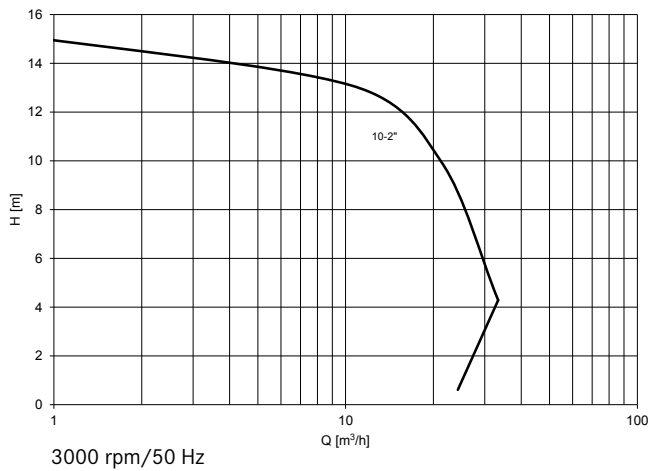

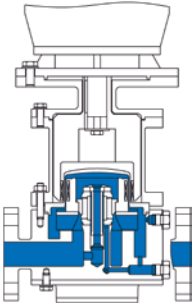

Vertical in-line close-coupled SZMK
with stand
-100°C to +200°C



SZMK with stand and motor
vertical in-line close-coupled (-100°C to +200°C)

Applications

Versatile – Complex – Special

CP's stainless steel magnetic drive pumps are engineered to meet the most stringent quality standards and ensure reliability and utmost safety in production operations. Suitable for many different fluids in a variety of industries and processes, they are capable of handling low, medium and high flow volumes. They offer tremendous advantages, especially in pumping very sensitive or hazardous substances.

Industries

- Chemical processing: basic and fine chemicals (agrochemicals, speciality chemicals)
- Pharmaceuticals
- Biotechnology processing
- Food and beverages
- Pulp and paper

Processes

CP's stainless steel magnetic drive pumps are designed for a wide range of processes, including:

- Dosing
- Laboratory applications
- Refrigeration and heating cycles

Fluids

CP's stainless steel magnetic drive pumps can handle acids, bases, solvents, suspensions, heat transfer liquids and other fluids.

For example:

- Acetone
- Brine
- Diphenylmethane diisocyanate
- Ethylene dichloride
- Ethylene glycol
- Hydrogen peroxide
- Sodium bisulphite
- Sulphuric acid

Our sales staff will be glad to give you personalised advice tailored to your specific needs, industry, processes and fluids.





Casing of the SZMK magnetic drive in-line chemical process pump

Options

Comprehensive – Individual – Combinable

Casing

Materials

- Stainless steel 1.4404/1.4435 (316L)
- Stainless steel (e.g. 1.4306, Uranus® B6)
- Duplex alloys (e.g. 1.4517)
- Nickel-base alloys (e.g. Hastelloy® C-4, C-22)
- Other materials (e.g. rolled bar stock) to meet customer needs

Pressure rating

- PN 16

Connection flanges

- To EN 1092-1
- Drilled to ANSI/ASME B16.5

Additional connections

- External flush connection for bearing lubrication
- Lantern monitoring connection

MKPP gasket materials

- FEP/FKM
- Kalrez®

SZMK gasket materials

- PTFE
- pure Graphite
- Sigma 511®/NT-CHEM-beige®

Plug seal materials

- PTFE
- Silver-plated nickel



Bearing assembly

Materials

- SSiC (sintered silicon carbide)
- SSiC with graphite
- SSiC with diamond-like coating (ADLC)
- Nickel-bound tungsten carbide
- Nickel-bound tungsten carbide with diamond-like coating (ADLC)



Containment shell

Materials

- Stainless steel
- Hastelloy® C



Pump protection

Containment shell thermocouple

Engine load sensor

Mounts

Types

- Stand
- Vertical
- In-line

Materials

- Steel
- Stainless steel

Stilts

Drip pan

Grounding lugs



Bearing frame

Lubrication

- Oil lubrication
- Grease lubrication

Oil lubrication options

- Hermetic seal (MagTecta OM™)
- Constant level oiler

Coupling

Coupling guard

- Steel
- Brass

The options vary depending on the pump model.
Our sales staff will be glad to advise you in detail.



Sectional Views

MKPP

vertical in-line close-coupled (-100°C to +200°C)

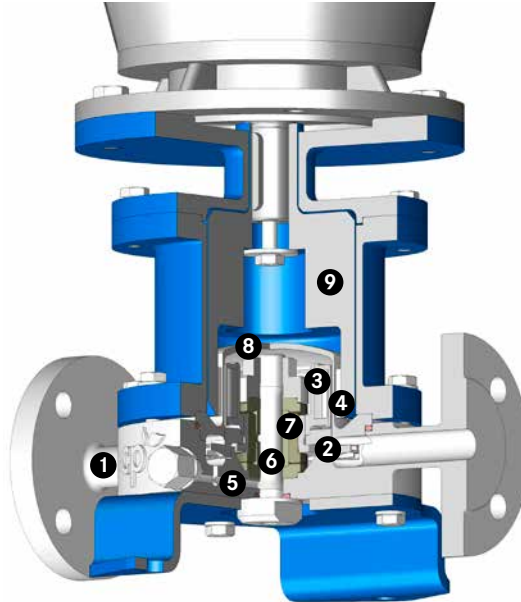

SZMK

vertical in-line close-coupled (-100°C to +200°C)

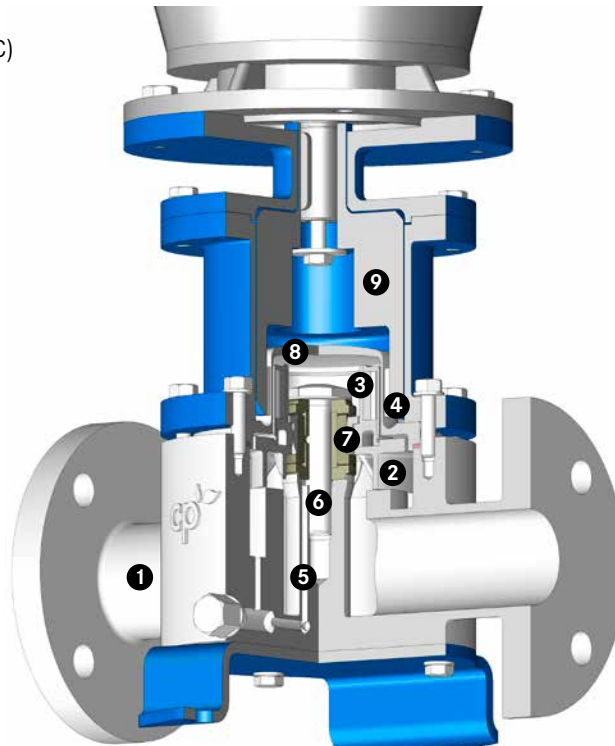

- 1 Pump casing
- 2 Impeller
- 3 Inner magnet assembly (on product side)
- 4 Outer magnet assembly (on atmospheric side)
- 5 Internal bearing lubrication or external flush connection

- 6 Single impeller locking sleeve
- 7 Plain bearing assembly
- 8 Hermetically sealed containment shell
- 9 Containment shell thermocouple



CP Pump Systems

Our Product Portfolio

Customer service

We offer the highest quality, many years of experience and first-class advice from a single source. Our bespoke pump systems meet a wide range of different requirements.

CP's customers benefit from a full service offering: the fastest availability of genuine spare parts, a complete set of technical documentation, competent and efficient customer support, and a dynamic and flexible repair service. All these services ensure that your pumps will operate faultlessly. Thanks to a network in over 70 countries, we advise and serve our customers directly on site.

Energy efficiency consulting

As a trend scout specialised in energy efficiency, CP can deliver a wide spectrum of services relating to pumps and motors: comprehensive advice, in-depth system analysis, meticulous planning and design. Our goal is to actively help our customers optimise the energy consumption of their pumping systems and thereby cut costs over the long term.

Backed by our many years of broad experience, we today advise and assist customers in both the private and public sectors. These include owners and operators of fluid processing plants in the chemical, pharmaceutical and diverse other industries.

Are you interested? Do you have any questions? We would be happy to discuss all the different options with you personally.

Stainless steel magnetic drive centrifugal pumps

MKP

Magnetic drive chemical process pump

MKP-S

Self-priming magnetic drive chemical process pump

MKTP

Magnetic drive chemical process sump pump

MKP-ANSI

Magnetic drive chemical process pump

MKPP

Magnetic drive in-line chemical process peripheral pump

SZMK

Magnetic drive in-line chemical process pump

Mobile centrifugal pump

Mobile magnetic drive chemical process pump

Stainless steel magnetic drive biotech process pump

MKP-Bio

Magnetic drive centrifugal pump for sterile processes

PFA lined magnetic drive centrifugal pumps

MKPL

Magnetic drive chemical process pump

MKPL-S

Self-priming magnetic drive chemical process pump

Solid PTFE magnetic drive centrifugal pumps

MSKP

Magnetic drive chemical process pump

MSKPP

Magnetic drive chemical process peripheral pump

MSKS

Self-priming magnetic drive chemical process side channel pump

Stainless steel mechanical seal centrifugal pumps

ZMP

Mechanical seal chemical process grinder pump

PFA lined double mechanical seal centrifugal pump

EB

Double mechanical seal chemical process pump

Ceramic lined double mechanical seal centrifugal pump

ET

Double mechanical seal chemical process pump



Improving energy efficiency in pumping systems helps to create a cleaner planet.



If empty, please find your local CP distributor on www.cp-pumps.com or contact CP directly: +41 62 746 85 85 / info@cp-pumps.com.

